

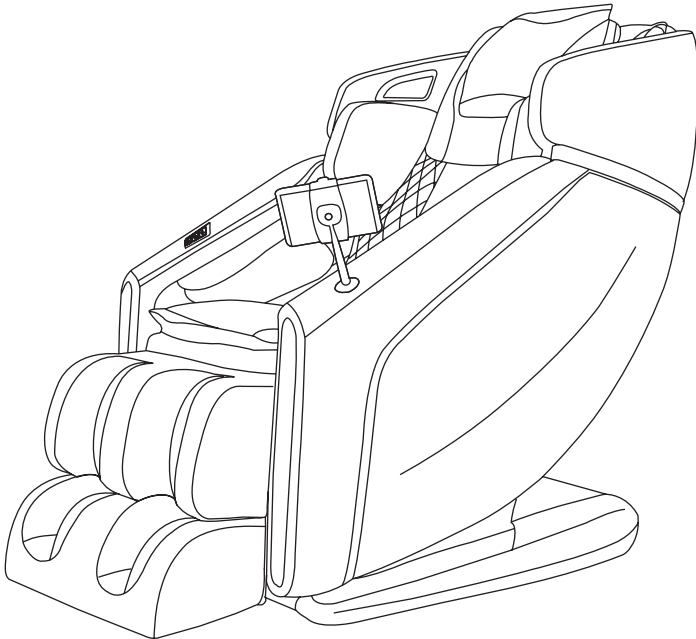

RockerTech[®]

by Infinity[®]

Sensation[™] 4D Massage Chair



User Manual

Welcome to



Thank you and congratulations on purchasing your very own RockerTech Massage Chair, you've made a great buying decision. Welcome to the RockerTech family.

Inside this manual, you will find everything you need to setup and safely enjoy your chair. Please review the entire manual before using your chair.

For convenience, we've also created a Quick Start Guide. We suggest you keep it as a tool to get to know all the features of your new chair.

Sit back, relax, and enjoy your new RockerTech massage chair!

Warranty Registration

Register your product at [www.rockertech.com](#) to ensure it is in our system. This will simplify the warranty process should you ever need it.

Alternatively, **scan the QR code** to go directly to the URL above.



SCAN CODE

Your Chair

External Structure

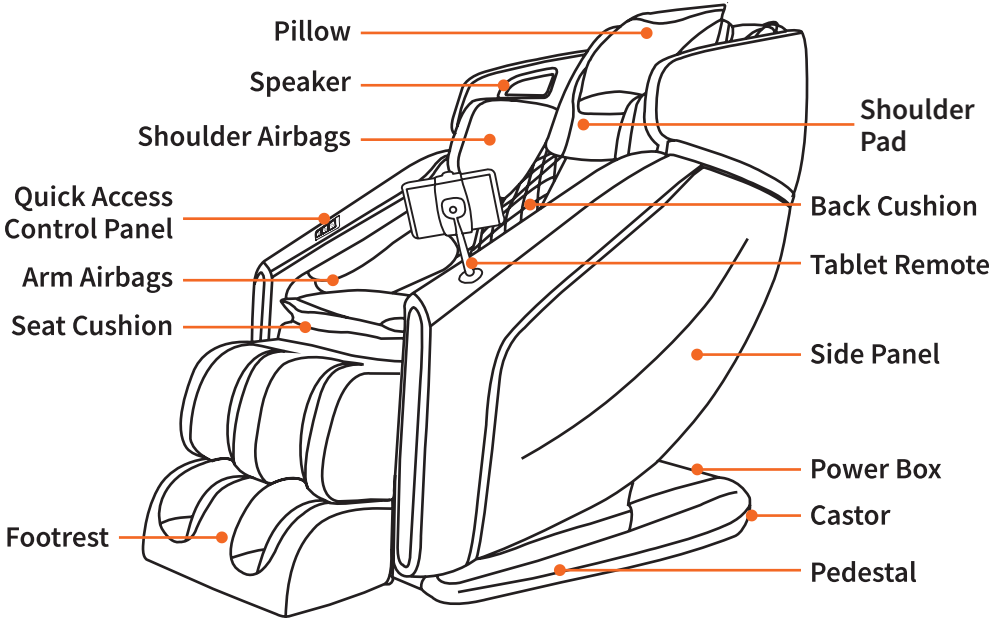

Tablet Remote Home Display Screen

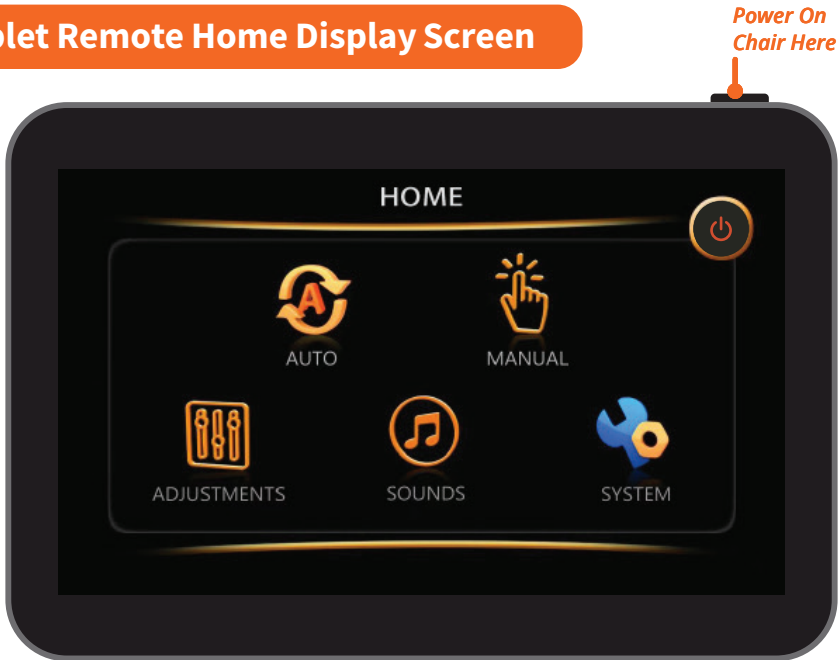

After turning on your chair, the Home screen display is the first screen you will see on your tablet remote. Use this screen to navigate all menu options. To select, simply tap the screen with your finger. Choose from the following:

POWER – Use the power button on the top right edge of the tablet to turn the chair on/off. Once the chair is on, you can now also tap the circular power button on the screen to turn the chair on/off.

AUTO – Select from 16 pre-set auto programs. To select simply tap the auto program you wish to run.

MANUAL – Have a particular spot that needs more work? Take the power of massage into your own hands with Manual Settings. Use this screen to fully customize your own massage and find the perfect treatment for you.

ADJUSTMENTS – While your massage program is running, use this screen to make adjustments to massage strength & speed, airbag intensity, or chair angles.

SOUNDS – Use this screen to select and control the SootheMe™ Sound Therapy feature of your chair. The selected sound will play from the Intersound™ speakers. To turn SootheMe™ nature sounds off, de-select the activated sound.

Chair Features

4D Back Massage Mechanism

L-Track Massage

Quick Access Control Panel

Tablet Remote Control

Foot Reflexology Rollers

Kneading Calf Rollers

SoothMe™ Sound Therapy

Lumbar Heat

Truefit™ Body Scanning

Zero Wall Fit™ Space-Saving Technology

16 Auto Programs

Customizable Manual Massage

Airbag Compression Therapy

Two Weightless Zero Gravity Positions

Table of Contents

Your Chair

| | |
|-----------------------------------|---|
| External Structure | 4 |
| Tablet Remote Home Display Screen | 5 |

Preparation

| | |
|-------------------------------|---|
| Installation Site | 8 |
| Clearance Space for the Chair | 8 |
| Floor Protection | 8 |
| Move Methods | 9 |
| Connect to Power | 9 |

Chair Setup

| | |
|--|----|
| Main Power Switch | 10 |
| Adjust Pillow | 10 |
| Increase the Intensity of your Massage - Manually | 10 |
| Truefit™ Body Scanning | 10 |
| Getting out of the Chair | 11 |
| Chair Entry and Exit Hazards | 11 |

Auto Programs

| | |
|------------------------------|----|
| Auto Programs (AUTO) | 12 |
| Remote Control In-use Screen | 12 |
| Auto Program Descriptions | 13 |

Customize Experience

| | |
|--------------------------------------|----|
| Custom Selections from In-Use Screen | 14 |
| Adjustments | 14 |
| Airbag Massage | 16 |
| Sounds | 16 |
| SoothMe™ Sounds Description | 17 |
| Voice Demo | 17 |
| Touch-tone | 17 |
| Bluetooth | 17 |
| Volume Level | 17 |
| Quick Access Control Panel | 18 |

Settings

| | |
|--------------------|----|
| System | 19 |
| Language | 19 |
| Display Brightness | 19 |
| Sleep Mode | 19 |
| Massage Time | 19 |
| Engineering Mode | 19 |

Manual Massage

| | |
|------------------------|----|
| Back Massage Technique | 20 |
| Focus Zone | 20 |
| Massage Width | 20 |
| Back Mechanism Adjust | 21 |
| Additional Settings | 21 |

Staying Safe

22

Fixing Issues

| | |
|---------------------------|----|
| Troubleshooting | 26 |
| FCC Information | 26 |
| Frequently Asked Question | 27 |
| Specifications | 27 |

Preparation

Installation Site

Clearance Space for the Chair

- 6" clearance for the recline of the backrest; 20" clearance for the extension of footrest and sliding forward of the chair.
- Keep it 3 feet away from the TV, radio or other audio & video appliance to avoid signal interference

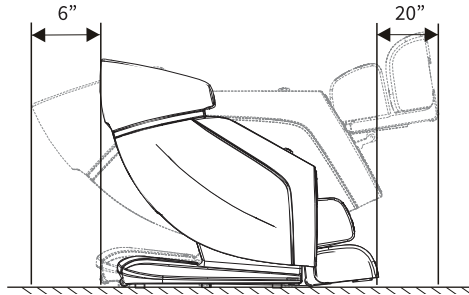

- Keep the distance between the power socket and power switch within 6 feet to avoid damage of power cord while massage chair sliding forward
- Straighten the power cord while in use to avoid tangle or damage.



- To avoid serious injury or death, before sliding chair forward or backward check to make sure area is clear of children, pets, or obstacles.

Floor Protection

To protect ANY floor type, hard surface or carpeted, from scratches or other markings, place the chair on a sacrificial pad or mat that extends from under the footrest to the rear of the chair.

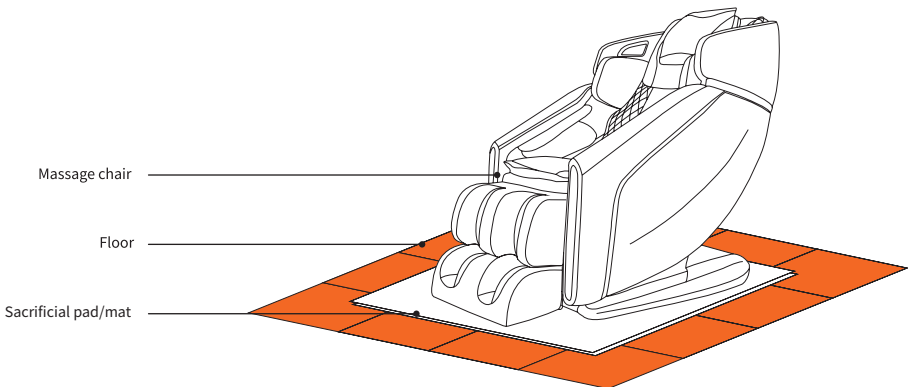

- Do not use the massage chair in high moisture environment such as near swimming pool or bathroom to prevent electric shock accident.
- Please keep the massage chair away from heated surfaces to prevent fire hazard or damage to the product.

Move Methods

- Apply pressure to the back of the massage chair from behind to pivot on the Castors. Have a second person up front to guide the Footrest until in the correct position. Maintain clearances as mentioned above. Gently lower into place. Do not pull on the side arms.

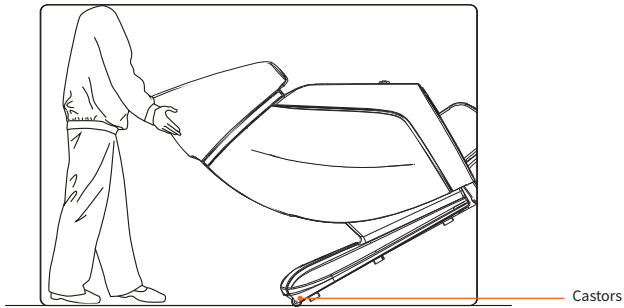

- Do not move the chair when there is user inside.
- Chair is heavy. Use caution and get assistance when lifting to avoid injury. Do NOT lift chair by footrest or armrests to avoid damage to product.

Connect to Power

Plug into a 110V grounded outlet.



WARNING

Grounding Instructions

To avoid risk of electrical shock, turn power switch off before plugging unit into electrical outlet. Use only with properly grounded outlet (3 prong). Do not plug into ungrounded outlet.

WARNING - Improper connection of the equipment-grounding conductor can result in a risk of electric shock. Check with a qualified electrician or serviceman if you are in doubt as to whether the product is properly grounded. Do not modify the plug provided with the product - if it will not fit the outlet, have a proper outlet installed by a qualified electrician.

This product is for use on a nominal 120-V circuit and has a grounding plug that looks like the plug illustrated. Make sure that the product is connected to an outlet having the same configuration as the plug. No adapter should be used with this product.

Earthing

This massage chair is a Class 1 electrical appliance. Make sure to use a grounded outlet to the grounded power supply circuit and a properly installed earth grounding rod with ground connection, to avoid electric shock.

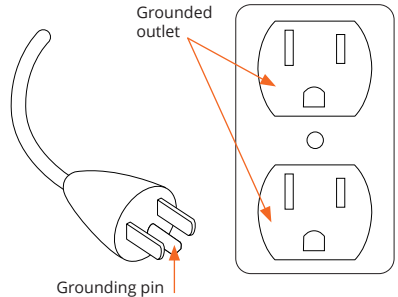

Chair Setup

Getting Comfortable

Main Power Switch

To power up the chair, flip up the main power switch located on the back of the base of the chair to **ON**.

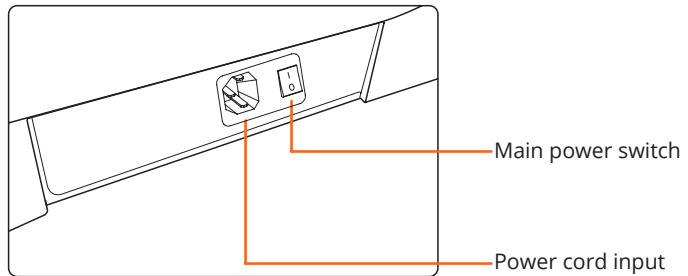

- To avoid possible damage to product or injury to unsupervised children, always turn off power switch and unplug massage chair from electrical outlet immediately after use.
- When not in use for a long period of time, we recommend that the chair be covered, the power cord be coiled and that the unit be placed in an environment free of dust and moisture.

Adjust Pillow

Take a seat in the chair and take note of where the neck pillow rests on your neck. Adjust the pillow so that it rests comfortably in the arch of your neck. Do this by removing it from the velcro, aligning it, and then reattaching to the velcro once it is in the desired position.

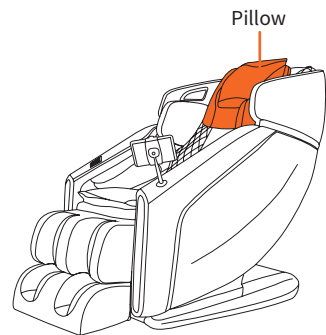

Increase the Intensity of your Massage - Manually

To make the massage more intense, remove the **neck pillow** and **shoulder pad** cushioning between you and the massage mechanism in the seat back.

Truefit™ Body Scanning

Select any auto program. The chair will automatically begin scanning your body, mapping your back, shoulders, and neck. During this process it is important to remain seated back into the chair without lifting your head.

The scan can be viewed on the tablet remote screen. If fine tuning is needed just after your body scan, use the **up** and **down arrow** buttons to move the massage rollers up or down for the perfect shoulder kneading position. Press OK to start massage.

Truefit™ Body Scanning



Press OK to start massage

Getting out of the Chair

To easily exit the chair at any time, press the **ON/OFF** power button on the tablet remote to restore the chair to the upright position.

WARNING! Check to make sure children and pets are clear of chair **before** pressing on/off button to return chair to upright position. See below for detailed hazard warnings.

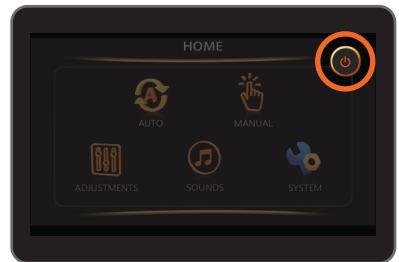

Chair Entry and Exit Hazards

WARNING! The areas under the footrest and behind the back rest are potentially dangerous for a child or pet. The chair back is heavy and reclines with force. A small child or pet located behind the chair could be crushed as chair is reclined resulting in serious injury or death. When chair is reclined, small children or pets who have crawled under the leg rest may not be visible to the user and could be crushed when leg rest is lowered or when chair is returned to upright position. **To avoid serious injury or death, check these areas carefully before reclining, lowering leg rest, or returning chair to upright position.**

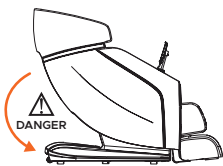

Make sure to check for children or pets **between the chair back and the base of the chair** before entering zero gravity recline.

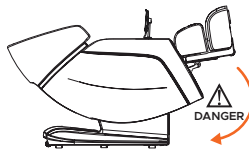

Make sure to check for children or pets **underneath the footwell** before exiting zero gravity recline and returning to upright position.

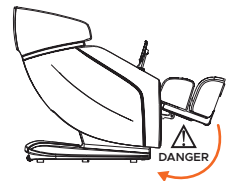

Make sure to check for children or pets **between the footrest and the chair body** before lowering the legrest.

Auto Programs

Auto Programs (AUTO)

From the home display screen, tap the **AUTO** button to enter the Auto Program display screen.

Choose from **Quick, Deep Relief, Refresh, Stretch, Soothe, Neck & Shoulder, Lower Body, Relax, Shiatsu, Rise & Shine, Recover, Rest & Sleep, Energize, Full Body, Wind Down, and Gentle** programs.

To enter the program you desire tap the screen. Selected program will show on the In-use screen.



Remote Control In-use Screen

While running an Auto Program or in Manual mode, the tablet remote control screen will return to the In-use screen (as shown) **after 10 seconds of being idle**. To exit the In-use display, press the **HOME** button at the top left of your tablet remote control.



- Do not spill liquids on Tablet Remote and avoid placing heavy objects on Tablet Remote or power cord to avoid damage or malfunction.



| Programs | What For? | Description |
|----------------------------|---|---|
| Quick | A quick way to feel all the massage techniques and chair movements in a brief 8 minute session. | A quick show of massage chair's features and functions, that can be accompanied by an explanatory voice over. The voice can be turned off and on in SOUNDS. |
| Deep Relief | This is a great program for people who work at a desk or travel a lot. | The most intense of the massage programs. This strong kneading and shiatsu massage effectively decompresses the entire body. |
| Refresh | Refresh your muscles and reduce tension carried in the body from everyday stress. | Total body relaxation with shiatsu and rolling massage techniques, and air cell massage. |
| Stretch | Great for midday recovery to relieve any built up morning stress. | Yoga like stretching motions grab, hold and gently extend the body, while deep shiatsu massage helps to boost the vitality of muscles. |
| Soothe | Need a quick break? Soothe tired and sore muscles, so that you can get back to what you love doing most. | A revitalising massage that is ideal for a mid-day boost. Full body kneading relieves built up stress, reduces fatigue, and improves metabolism so you can finish your day off strong. |
| Neck & Shoulder | Relieve pain and tension in the neck and shoulders. | A powerful combination of kneading, grabbing, and pressing massage techniques target the neck, shoulder, and upper back to help ease unwanted pain and stiffness. |
| Lower Body | Improve hip mobility and reduce lower back pain. | Designed to stimulate the waist, hips and buttock, this sequence of massage and air bag compression can help to improve your range of motion, and reduce lower back pain so you can return to your feet feeling renewed. |
| Relax | Feeling tight and worked up? Use this program to melt away stress and relax. | Featuring slow kneading this massage relaxes muscles, improves circulation and aids in recovery. |
| Shiatsu | Helps to relax and recover tired and sore muscles. Whole body massage with a focus on the main back muscles along your spine. | Deep shiatsu on the back for 10 minutes. |
| Rise & Shine | Try this program first thing in the morning to prepare your muscles for the stress of the day. | Targeted airbag compression provides a full body stretch while the 4D back mechanism performs a combination of massage techniques to help awaken and ignite your muscles for the day ahead |
| Recover | Soothe muscles after sports activities and exercise. | Relaxes muscles and speeds up recovery time after intense exercise by promoting circulation. |
| Rest & Sleep | Designed for relaxing. Try this program as you prepare your body to rest for the night. | A progression of mild massage techniques and chair movements brings harmony to your body. This program helps you unwind from a long day, and prepares you for a restful night's sleep. |
| Energize | Recharge and re-vitalize your tired muscles after physical exertion. | Uses moderate pressure to decrease recovery time after physical exertion, relieve the body of stress and improve circulation. |
| Full Body | This program is the best choice to re-energize tired muscles and reset your mind. | This program is designed to relax the body both physically and emotionally. A unique combination of varying intensities brings the mind into a peaceful state, while specific massage techniques increase circulation to help relieve muscular tension, and reduce recovery time. |
| Wind Down | Best for winding down and re-energizing yourself after a long day. | As the lowest intensity massage, this series of massage techniques is perfect for those who are more sensitive, or looking for a light kneading motion on the back, waist and hips. |
| Gentle | Unwinding after a stressful day. | Designed to clear the mind and increase blood circulation. Breathe in deeply and exhale your stress while this rhythmic massage program works to alleviate your tired muscles and reinvigorate your spirit. |

Customize Experience

Custom Selections from In-Use Screen

To personalize your massage experience, you can adjust settings straight from the In-Use Screen. Simply tap the screen to adjust **4D Intensity**, or toggle on/off **lumbar heat**, **foot rollers**, and **calf rollers**.



4D Intensity

Use this control to increase or decrease the intensity of the 4D back mechanism that works the back and shoulder regions. Use the + button to increase 4D intensity, use the - button to decrease 4D intensity.

Heating

Use this control to activate heat in the lumbar region to soothe muscles. Press once to turn **on** lumbar heat, Press again to turn **off** lumbar heat.

Foot Rollers

Use this control to activate Reflexology Foot Rollers. Press once to turn **on** foot rollers, Press again to turn **off** foot rollers.

Calf Rollers

Rollers combine with compression air cells to simulate hands gently relieving tension and pain in the calf region of each leg. Press once to turn **on** calf rollers, Press again to turn **off** calf rollers.

Adjustments

The **Adjustments** display screen can also be used to further tailor your massage exactly to your needs. Here you will have complete control over massage strength, and chair angles.

You can enter the adjustments screen from the home display screen, or by pressing the  icon at the bottom of your tablet remote whilst on the in-use screen.

To return to the In-use screen, simply tap the  icon on the bottom of the Tablet Remote screen. Press the return button on the bottom left of the screen to return to the previous screen.

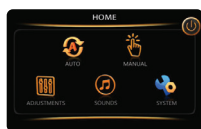

Tap Adjustments button



Return Button



4D Intensity

Use this control to increase or decrease the intensity of the 4D back mechanism that works the back and shoulder regions. Tap anywhere on setting to increase 4D intensity 1 step per tap. Once Maximum setting is reached, the next tap will cycle back to the lowest 4D intensity setting.

Kneading Speed

Use this control to increase or decrease the kneading speed of the 4D back mechanism. Tap anywhere on setting to increase kneading speed 1 step per tap. Once Maximum setting is reached, the next tap will cycle back to the lowest kneading speed setting.

Tapping Speed

Use this control to increase or decrease the tapping speed of the 4D back mechanism. Tap anywhere on setting to increase tapping speed 1 step per tap. Once Maximum setting is reached, the next tap will cycle back to the lowest tapping speed setting.

Air (Air bag) Intensity

Use this control to increase or decrease the intensity of the airbag massage. Tap anywhere on setting to increase airbag intensity 1 step per tap. Once Maximum setting is reached, the next tap will cycle back to the lowest airbag intensity setting.

Leg/Back Angle Adjust

Need to adjust the position of the footrest or backrest? Use the **Leg up/down buttons** or **Back up/down button** to fine-tune your angles. To adjust the footrest or backrest angle up or down, press the corresponding button. Press and hold button for faster adjustment.

Weightless Zero Gravity

Weightless Zero Gravity Recline elevates your feet up over your heart to improve overall circulation and reduces gravitational force on your spine for a sense of weightlessness.

Customize Experience

Airbag Massage

Your Sensation 4D massage chair also has the ability to control the air massage feature. Simply tap the  icon to enter the Air Massage display screen, where you can adjust the airbag massage region. Press the return button on the bottom left of the screen to return to the previous screen.



Tap Air Massage icon

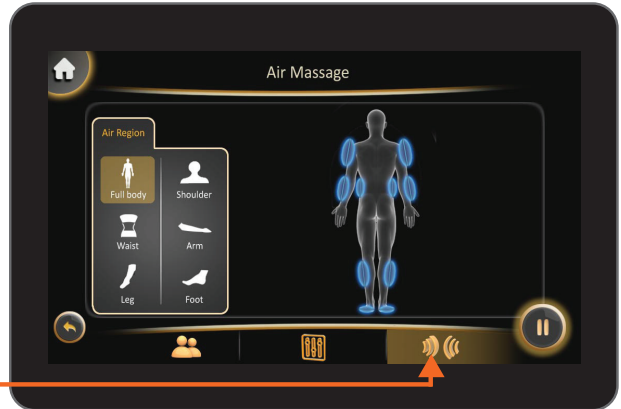

Air Region

Choose your desired airbag region/s: **Full Body, Waist, Leg, Shoulder, Arm or Foot**. Tap screen to select setting. To turn a particular airbag region off, de-select the activated region. Selecting **Full Body** will override any selections and ALL airbags become active.

Sounds

Tap **Sounds** on the home display screen to enter the Sounds display screen. Use this screen to select and control SootheMe™ Sound Therapy, toggle on/off Voice Demo, Touch-tones, and Bluetooth, or adjust Volume.

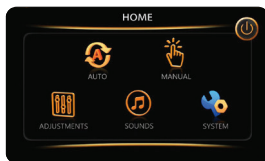

Tap Sounds button

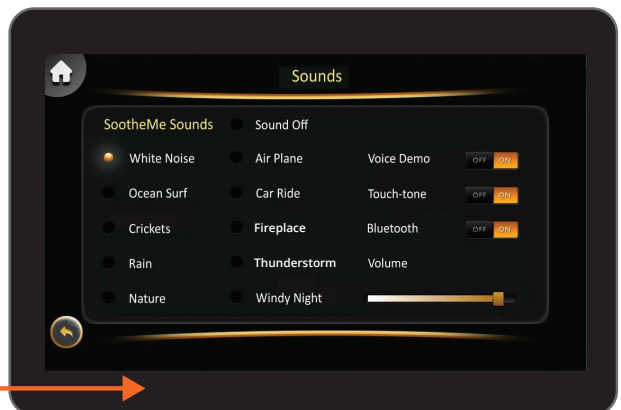

SoothMe™ Sounds

No need to find something to stream with on-board SootheMe™ Nature Sounds to choose from. Envelope yourself in soundscapes that are designed to help you relax. Use this setting to select and control the SootheMe™ Sound Therapy feature of your chair. The selected sound will play from the speakers next to your head. To turn SootheMe™ Nature Sounds off, select the **Sound Off** option.

Note: Bluetooth must first be turned on in Sounds screen.

| Sound | Description |
|---------------------|---|
| White Noise | A constant, even loop of pure white noise to mask out distractions |
| Ocean Surf | Soothing ocean waves rolling onto the shore |
| Crickets | Night time in the suburbs. Churping Crickets, water trickling from a pond, and faint traffic noises |
| Rain | Quiet, light, refreshing rain falling to the ground |
| Nature | Refreshing sounds of small birds peacefully singing along a tranquil stream. |
| Air Plane | A Cessna propeller airplane motor idling |
| Car Ride | Calming inner-city traffic featuring cars, trucks, and motorcycles |
| Fireplace | Crackling of fire in a fireplace |
| Thunderstorm | Heavy rainstorm with thunder |
| Windy Night | Heard from inside a cabin, a howling wind blows constantly outside |

Note: Bluetooth must be turned on for SootheMe™ Nature Sounds to work.

Voice Demo

Voice demo talks you through the functionality of the chair in the Demo auto program. Toggle your desired voice demo setting: **On** or **Off**. Tap screen to select setting.

Touch-Tone

Control whether you receive audible feedback after tapping the screen to select a setting. Toggle your desired touch-tone setting: **On** or **Off**. Tap screen to select setting.

Bluetooth

Toggle your chair's Bluetooth® setting: **On** or **Off**. Tap screen to toggle setting. Open Bluetooth from audio device and pair with **Sensation 4D** to play music.

In order to play SootheMe™ nature sounds from your chair, or to play music from your Bluetooth® enabled audio device, Bluetooth® must first be turned **on**.

Volume Level

Increase or decrease volume of SootheMe™ Nature Sounds and Bluetooth® audio. Press and drag dial to adjust volume up or down.

Customize Experience

Quick Access Control Panel

The Quick Access Control Panel allows you to turn the chair on and off, pause your massage, and cycle through the auto programs.

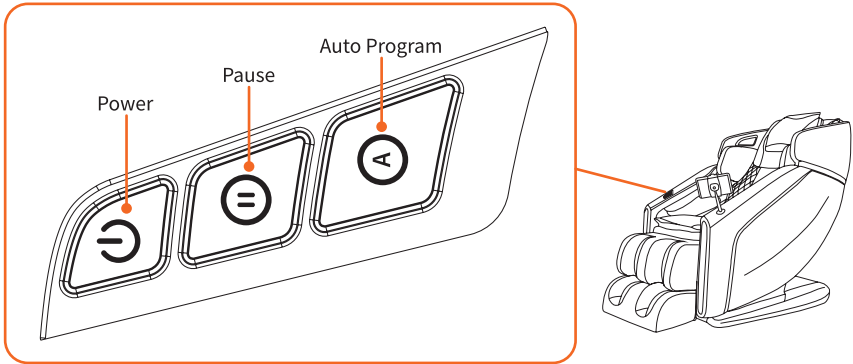

Power – Press of power button turns massage chair on/off.

Pause – Press to pause massage program. Press again to resume massage program.

Auto Program – Short press to cycle through all auto programs. Name of program is shown on screen.

Settings

System

Tap **System** on the home display screen to enter the System display screen. Use this screen to adjust and personalize your chair and tablet remote settings. Press the return button on the bottom left of the screen to return to the previous screen.

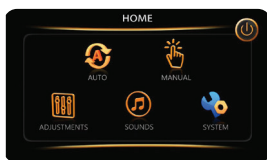

Tap System button

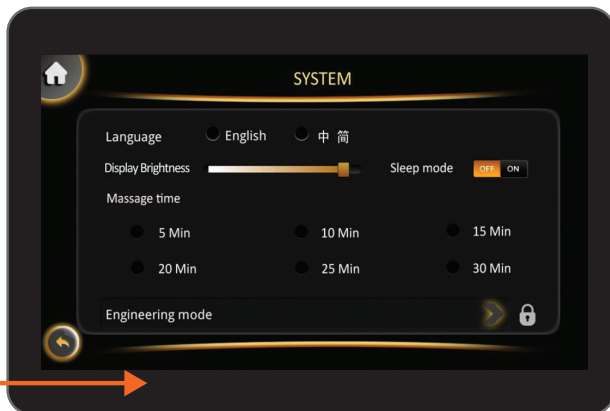

Language

Control your desired **language** setting: **English**, **Korean**, **Spanish** or **Chinese**. Tap screen to select setting.

Display Brightness

Control your desired Tablet Remote screen brightness setting: Press and drag dial to adjust screen brightness up or down.

Sleep Mode

Toggle your desired sleep mode setting: **On** or **Off**. Tap screen to select setting. When sleep mode is **on** the chair will stop in the reclined position after Auto Programs, when sleep mode is **off** the chair will return to a fully upright position after each Auto Program.

Massage Time

Tap screen to select your desired massage timer length; **5 minutes**, **10 minutes**, **15 minutes**, **20 minutes**, **25 minutes** or **30 minutes**. 15 minutes is the default setting. The massage chair will turn off automatically and reset after the timer is up.

Engineering Mode

Tap screen to enter engineering mode. This is for tech support to run tests should your chair need servicing.

Manual Massage

Manual

Have a particular spot that needs more work? Take the power of massage into your own hands with Manual Settings. Tap **Manual** on the home display screen to enter the Manual display screen. Use this screen to fully customize your own massage and find the perfect treatment for you.

Simply tap the screen to choose your desired massage technique, massage position, massage focus zone, and to toggle on/off back heat, foot rollers, and calf rollers. Your first selection on this screen will start your massage.

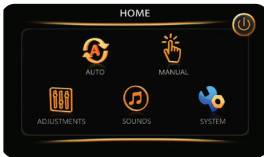

Tap Manual button



Back - Massage Technique

Controls the massage technique of the back mechanism. Select from: **Kneading**, **Shiatsu**, **Swedish**, **Knocking**, **Tapping** or **Rolling**. Tap screen to select. Tap technique a second time to enter a faster variation of that technique.

Number in top right corner represents active variation. Rolling has only one speed.

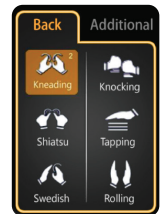

Focus Zone

Controls the range of motion of the back mechanism. **Full** travels the entire length of the track, **Partial** travels a short distance and reverses direction for focused relief, **Point** stops on the track for targeted relief. Tap screen to select setting.



Back Mechanism Adjust

Partial and Point location can be fine tuned by using the Adjust setting. Use the arrow up or arrow down buttons to control the location of the back mechanism.



Massage Width

Press to cycle through varying width settings of back mechanism. Choose from: **Narrow**, **Medium**, or **Wide**. Tap screen to select setting.

Width can't be adjusted when in Kneading, or Swedish modes.



Additional Settings

Tap **Additional**, located next to Back, to control features of your chair such as Back heat, Foot rollers, and Calf rollers. To return to the Back menu display to change your massage technique, simply tap **Back**.

Back Heat

Use this control to activate heating nodes in the lumbar region to soothe muscles. Press once to turn **on** lumbar heat, Press again to turn **off** lumbar heat. setting.

Foot Rollers

Use this control to activate Reflexology Foot Rollers. Press once to turn **on** foot rollers, Press again to turn **off** foot rollers.



Calf Rollers

Rollers combine with compression air cells to simulate hands gently relieving tension and pain in the calf region of each leg. Press once to turn **on** calf rollers, Press again to turn **off** calf rollers.

Adjustments

The **Adjustments** display screen can be used to tailor your massage exactly to your needs. Here you will have complete control over massage strength, and chair angles. **See page 15** for detailed breakdown of Adjustment display screen settings.

You can enter the Adjustments display screen from the home display screen, or by pressing the  icon at the bottom of your tablet remote whilst on the In-use screen.

To return to the In-use screen, simply tap the  icon on the bottom of the tablet remote screen. Press the return button on the bottom left of the screen to return to the previous screen.

Air Massage

The **Air Massage** display screen can be used to adjust the airbag massage region. **See page 16** for detailed breakdown of Air Massage display screen settings.

To enter the Air Massage screen, simply press the  icon on the bottom of the tablet remote screen.

To return to the In-use screen, simply tap the  icon on the bottom of the tablet remote screen. Press the return button on the bottom left of the screen to return to the previous screen.

Staying Safe

Safety Information

To ensure safe use of the massage chair and avoid injury or unsafe conditions, please read and follow all instructions before using product. **SAVE THESE INSTRUCTIONS.** Household use only.

WARNING

USE NOT RECOMMENDED FOR CERTAIN PERSONS

Use of massage chair may not be safe or suitable for persons with certain medical conditions and could cause serious injury or death in some circumstances. If you have any of the following conditions, please consult a physician before using the massage chair:

- Use of implanted electronic medical devices (such as a cardiac pacemaker)
- Pregnancy
- Cancer, malignant tumors, or other growths
- Osteoporosis or spinal fracture
- Other fractures or musculoskeletal injuries
- Loss of or reduced sensitivity to heat
- Implanted medical fixation devices such as rods, pins, etc.
- Recent surgery or sutures
- Skin diseases or skin injury
- High fever
- Certain pulmonary or breathing conditions
- Impaired circulation

WARNING

To avoid possible death or serious injury to user or others, please read and follow these instructions:

- **The areas under the footrest and behind the back rest are potentially dangerous for a child or pet. The chair back is heavy and reclines with force. A small child or pet located behind the chair could be crushed as chair is reclined resulting in serious injury or death. When chair is reclined, small children or pets who have crawled under the leg rest may not be visible to the user and could be crushed when leg rest is lowered or when chair is returned to upright position. To avoid serious injury or death, check these areas carefully before reclining, lowering leg rest, or returning chair to upright position.**
- **Chair should not be used by children under age 14.** Small children could be trapped or injured by airbags, heating mechanism, or moving parts. When chair is not in use, unplug unit and secure chair so that children cannot accidentally power on and operate chair.
- Children over age 14, persons with reduced physical, sensory, or mental capabilities, and elderly or frail persons should exercise caution and use massage chair only when supervised or assisted by a person over 16 years of age.
- Chair has a heated surface and could cause burns, particularly in persons with reduced sensitivity to heat. Such persons should use the chair only after consulting with a physician and should use extreme caution during any physician-approved use.

CAUTION

To avoid the risk of minor injury or discomfort, or damage to the massage chair or other property, please read and follow these instructions for safe use of massage chair:

- Do not stand or stack heavy objects on footrest.
- Do not operate heating features of chair while under a blanket or pillow. Excessive heating can occur and cause fire, electric shock, or injury to persons.
- To avoid pinching or crushing, please do not place body parts, especially fingers and toes, between parts of chair and keep clear of moving parts.
- To avoid overheating, injury or discomfort from overuse, do not fall asleep while using massage chair and do not use for extended periods of time (longer than 20 minutes).
- Avoid use while under the influence of alcohol, medications or other substances that may cause drowsiness, disorientation, or impairment of judgment or motor skills.
- Do not use the massage chair right after a meal, as it may cause discomfort.
- If you feel any abnormal discomfort during the operation of the massage chair, turn off the power immediately and discontinue use.
- Do not use this appliance when ambient temperature is over 40 C (104 F).
- Do not use this appliance in humid or dusty environment, or when any part of the body is in contact with plumbing or any similar ground.
- Never operate the appliance with the air openings blocked. Keep the air openings free of lint, hair, dust and the like.
- Do not use outdoors.
- Do not operate where aerosol (spray) products are being used or where oxygen is being administered.
- Place the product on a flat, level floor to reduce risk of tipping or overturning.
- Do not use or store near heat or open flame.
- Intended only for users who weigh below 265 lbs.
- Use this product only for its intended use as described in this manual. Do not use attachments not recommended by the manufacturer.
- Massage chair intended only for use by one person. Do not use by two or more persons at the same time to avoid damage to the product.
- Do not allow children to stand, jump, or play on or around massage chair, even when it is not powered on or in use.
- Remove personal accessories such as jewelry from arms and empty pockets, and remove loose clothing while using the massage features of the chair.
- Check the upholstery under the cushions and other spots for damage or loose objects that may cause injury or damage chair while operating. If any damage is present, do not use the massage chair and refer to a qualified service professional for servicing.
- To avoid damage to chair, walls, or other objects, make sure there are no obstacles behind the chair and there is enough clearance before adjusting the backrest or leg rest angle.
- Please be seated properly while using the product.
- To avoid damage to chair or floors, do not drag or push the chair or roll its casters on wood floor or carpet. See instructions on p.9 for safely moving chair.
- If massage chair is not working properly, has been dropped or damaged, or has been dropped into water or exposed to flooding, return the appliance to a service center for examination and repair before attempting to use.
- Do not drop or insert any object into any openings in chair.

Staying Safe

WARNING

Read and follow these instructions concerning safe use of the power cord and power unit to avoid possible electric shock, fire hazard, use of chair by and injury to unattended children, or damage to chair or other property.

- *To avoid risk of electric shock, connect this unit to a properly grounded outlet only. See Grounding Instructions on pg. 9.*
- *Always unplug massage chair from the electrical outlet immediately after use and before cleaning. An appliance should never be left unattended when plugged in. To disconnect, turn all controls to the off position, then remove plug from outlet.*
- *Do not use massage chair and unplug from outlet during thunder or lightning storms, and before putting on or taking off parts.*
- *To ensure safe operation, power must be supplied only at standard 110 voltage, to the specifications of the appliance. Confirm that the power voltage stated on the rating label corresponds to your local electricity supply.*
- *The massage chair should be used only with the power supply unit provided. Do not use with any other power source.*
- *Do not use a wet or damp hand to unplug the cord to avoid electric shock.*
- *Do not pull on the power cord to unplug. Grip by plastic end nearest outlet to unplug power cord.*
- *Do not squeeze, over bend, pull hard, or twist the power cord.*
- *Keep the power cord away from heated surfaces.*
- *Do not carry or drag the chair by power cord or use cord as a handle.*
- *If there is any smoke or unusual smell while using massage chair, stop using immediately and unplug the power cord.*
- *Never operate the chair if it has a damaged power cord or plug. If the power cord is damaged, it must be replaced by the manufacturer or its service agent or a similarly qualified person to avoid a hazard.*

Do not disassemble, dismantle or attempt to repair massage chair. Such actions, as well as misuse of product, may cause damage to or failure of massage chair and may void the manufacturer's warranty. For repairs, please contact an authorized dealer or repair agent at 603-910-5000. For additional details concerning terms, conditions and limitations of warranty, see <https://rockertechmassage.com/warranty-info>.

Fixing Issues

Trouble Shooting

| Symptoms | Possible Causes | Possible Solution |
|---|---|--|
| Noise is heard while in use | These noises are normal and arise from friction between the massage rollers and the leather cover | No need to take any measures |
| Massage Chair does not start | The power cord is not secured into the socket Not switched ON The fuse is blown | Insert the power plug properly into the power socket Turn on the switch found on chair side. Then push power button on remote Replace only with a fuse of same type and rating |
| No music comes from the speaker | The volume on your device is turned to the lowest setting | Ensure the volume on your device is turned up and the Bluetooth pairing was successful |
| Backrest or footrest can not raise or recline | Excessive load has been pressed on the backrest or legrest | Reduce the load and try again |

FCC Information

This device complies with part 15 of the FCC Rules. Operation is subject to the following two conditions: (1) This device may not cause harmful interference, and (2) this device must accept any interference received, including interference that may cause undesired operation. Changes or modifications not expressly approved by the party responsible for compliance could void the user's authority to operate this device.

NOTE: This equipment has been tested and found to comply with the limits for a Class B digital device, pursuant to part 15 of the FCC Rules. These limits are designed to provide reasonable protection against harmful interference in a residential installation. This equipment generates, uses, and can radiate radio frequency energy and, if not installed and used in accordance with the instructions, may cause harmful interference to radio communications. However, there is no guarantee that interference will not occur in a particular installation. If this equipment does cause harmful interference to radio or television reception, which can be determined by turning the equipment off and on, the user is encouraged to try to correct the interference by one or more of the following measures:

- Reorient or relocate the receiving antenna.
- Increase the separation between the equipment and receiver.
- Connect the equipment into an outlet on a circuit different from that to which the receiver is connected.
- Consult the dealer or an experienced radio/TV technician for help.

Frequently Asked Questions

Q: I find the chair is too intense to be comfortable. What can I do?

A: Your body needs to become acclimated to therapeutic massage. To be effective, the massage techniques must compress the tissue in your body. We recommend the following steps to help get started. Then over time as your body acclimates you can increase the intensity by reducing the layers between you and the chair.

1. Use the neck pillow and shoulder pad to reduce upper body intensity.
2. From the Auto program In-use display screen, use the **4D intensity** setting to decrease the Intensity of the back massage mechanism. While in Manual program, navigate to the Adjustment display screen to decrease 4D intensity setting.
2. From the In-use display screen tap the **Air Massage icon** to adjust air massage region
 - If a specific airbag is too intense, turn off full body and turn on only the airbags you want.
3. From the Adjustments display screen, use the **Air Intensity** setting to decrease the air massage intensity.
4. Adjust the recline on the remote. More upright will be less intense. Zero Gravity will be more intense.
5. If after adjustments and attempt to acclimate, you still experience discomfort, discontinue use and

Q: I'm not a foot massage person, what should I do?

A: Turn off foot rollers. While in Auto program In-use screen simply tap the foot rollers setting to turn off. While in Manual program, select additional settings, and then tap the foot rollers setting to turn off.

Q: My chair is not performing as expected. What should I do?

A: Your RockerTech massage chair is an amazing combination of programming and robotics. On occasion the chair just may need to be rebooted. To do this power down the chair and unplug from the wall for 5 minutes then plug back in and power back up to see if it self-healed. If you are still having an issue, give RockerTech a call at 603-910-5000.

Specifications

| | |
|---|--------------------|
| Model | Sensation 4D |
| Dimension of Main Body (in) | 48.4 x 32.1 x 48.8 |
| Necessary Clearance to Wall (in) | 6" |
| Net Weight (lbs) | 200 |
| Shipping Weight (lbs) | 231 |
| Max. User Weight (lbs) | 300 |
| Voltage | 120V~ |
| Frequency | 60Hz |
| Rated Current | 1.5A |



72 Stard Road, Seabrook, NH 03874

(603) 910-5000

www.rockertechmassage.com

Version 1.1